

Digital Integrated Amplifier

CA-S3

Owner's Manual

Thank you for purchasing the CA-S3.
In order to use the product in a safe manner, please read this Owner's Manual thoroughly before using.
Also, keep this manual for future reference.

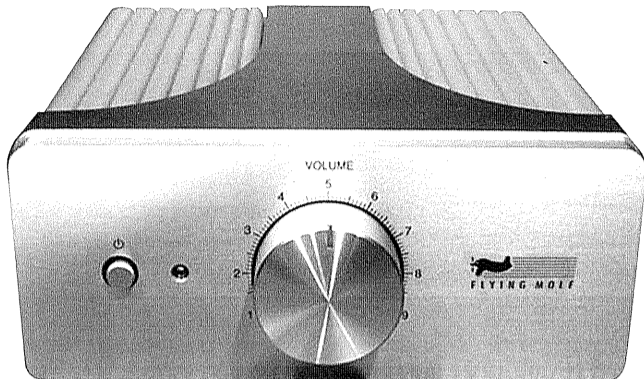

Accessory Checklist

Before proceeding with the setup, make sure that the following accessory is included in the package. If it is missing, please contact the dealer whom you purchased the amplifier from, or Flying Mole Corp.

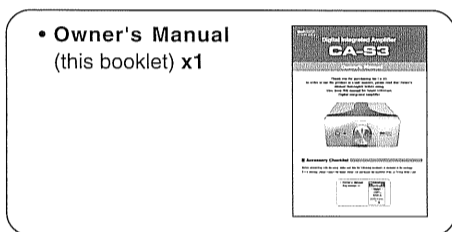

Safety Instructions

THE APPARATUS IS NOT WATERPROOF. TO PREVENT FIRE OR SHOCK HAZARD, DO NOT EXPOSE THIS APPLIANCE TO RAIN OR MOISTURE AND DO NOT PUT ANY WATER SOURCE NEAR THIS APPARATUS, SUCH AS VASE, FLOWER POT, COSMETICS CONTAINER AND MEDICINE BOTTLE, ETC.

IMPORTANT NOTICE

If this product is found to be the source of interference, which can be determined by turning the unit "OFF" and "ON", please try to eliminate the problem by using one of the following measures : Relocate either this product or the device that is being affected by the interference. Utilize power outlets that are on different branch (circuit breaker or fuse) circuits or install AC line filter/s.
 In the case of radio or TV interference, relocate/reorient the antenna.
 If the antenna lead-in is 300 ohm ribbon lead, change the lead-in to coaxial type cable.
 If these corrective measures do not produce satisfactory results, please contact the local retailer authorized to distribute this type of product.
 If you can not locate the appropriate retailer, please contact Flying Mole Corporation.

2 Features

- **High Quality Sound Design**
 - Utilizing the acclaimed Bi-Phase PWM amplifier technology used in our DAD-M100pro
 - Original speaker connectors with large contact area
 - Ultra-high quality One Pole Pre-Amplifier minimizes sound deterioration at the low level of volume
- **Gorgeous Chassis**
 - CD-case-size compact body with 10 mm thick aluminum front panel realizes high rigidity and superb vibration suppression
- **Environmentally Friendly Design**
 - Total efficiency of 80% at rated output : an amazing low power consumption
 - Complying with *RoHS directives

* **Restriction of Hazardous Substances (RoHS) directives :**
 Use of six (6) kinds of substances (lead, mercury, cadmium, hexavalent chromium, polybrominated biphenyl, and polybrominated diphenyl ether) are restricted.

1 Safety Instructions

CAUTION

RISK OF ELECTRIC SHOCK

DO NOT OPEN

CAUTION : TO REDUCE THE RISK OF ELECTRIC SHOCK, DO NOT REMOVE COVER (OR BACK). NO USER-SERVICEABLE PARTS INSIDE. REFER SERVICING TO QUALIFIED SERVICE PERSONNEL.

THIS SYMBOL INDICATES THAT DANGEROUS VOLTAGE CONSTITUTING A RISK OF ELECTRIC SHOCK IS PRESENT WITHIN THIS UNIT.

THIS SYMBOL INDICATES THAT THERE ARE IMPORTANT OPERATING AND MAINTENANCE INSTRUCTIONS IN THE OWNER'S MANUAL WITH THIS UNIT.

WARNING : To reduce the risk of fire or electric shock, do not expose this apparatus to rain or moisture.

The important safety instructions

- Read these instructions.
- Keep these instructions.
- Heed all warnings.
- Follow all instructions.
- Do not use this apparatus near water.
- Clean only with dry cloth.
- Do not block any ventilation openings. Install in accordance with the manufacturer's instructions.
- Do not install near any heat sources such as radiators, heat registers, stoves, or other apparatus (including amplifiers) that produce heat.
- Do not defeat the safety purpose of the polarized or grounding-type plug. A polarized plug has two blades with one wider than the other. A grounding type plug has two blades and a third grounding prong. The wide blade or the third prong are provided for your safety. If the provided plug does not fit into your outlet, consult an electrician for replacement of the obsolete outlet.
- Protect the power cord from being walked on or pinched particularly at plugs, convenience receptacles, and the point where they exit from the apparatus.
- Only use attachments/accessories specified by the manufacturer.
- Use only with the cart, stand, tripod, bracket, or table specified by the manufacturer, or sold with the apparatus. When a cart is used, use caution when moving the cart/apparatus combination to avoid injury from tip-over.
- Unplug this apparatus during lightning storms or when unused for long periods of time.
- Refer all servicing to qualified service personnel. Servicing is required when the apparatus has been damaged in any way, such as power-supply cord or plug is damaged, liquid has been spilled or objects have fallen into the apparatus, the apparatus has been exposed to rain or moisture, does not operated normally, or has been dropped.

3 Component Names

Front Panel

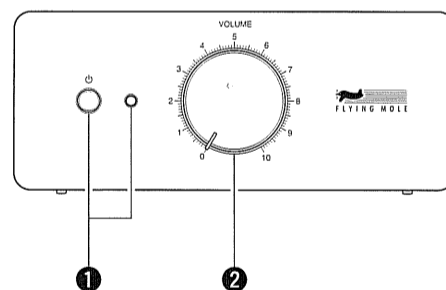

- Power Switch/Power Indicator**
Used to turn the amplifier's power ON or OFF. The indicator lights when the power is turned ON.
- VOLUME Controller**
Controls the output level. Setting the controller to "0" turns down the volume to the minimum.

Rear Panel

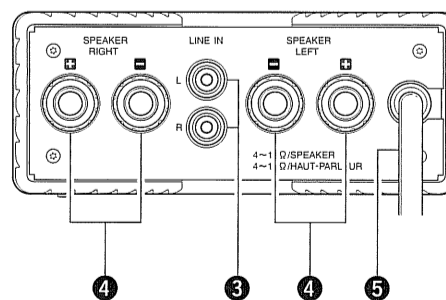

- INPUT Jacks**
Used to connect the input signal to the amplifier. Connect the jacks to the LINE OUT jacks on a CD player, etc.
- SPEAKER Connectors**
(*Be sure to check polarity before connection)
Used to connect the amplifier to the speaker. Make sure that the speaker's impedance is between 4 ohms and 16 ohms.
- AC Power Cable**
Connect this cable to AC outlet.

4 Connections

Connecting Devices

- Make sure the power of all related equipments is turned off, when wiring and checking their polarity.
- Make sure that the speaker cable connection is not shorted, before power switch is turned on.
- Connect the power cable after all connections are complete.
- Jack names may be different from this manual.

* Refer to the owner's manuals of the devices to be connected as well.

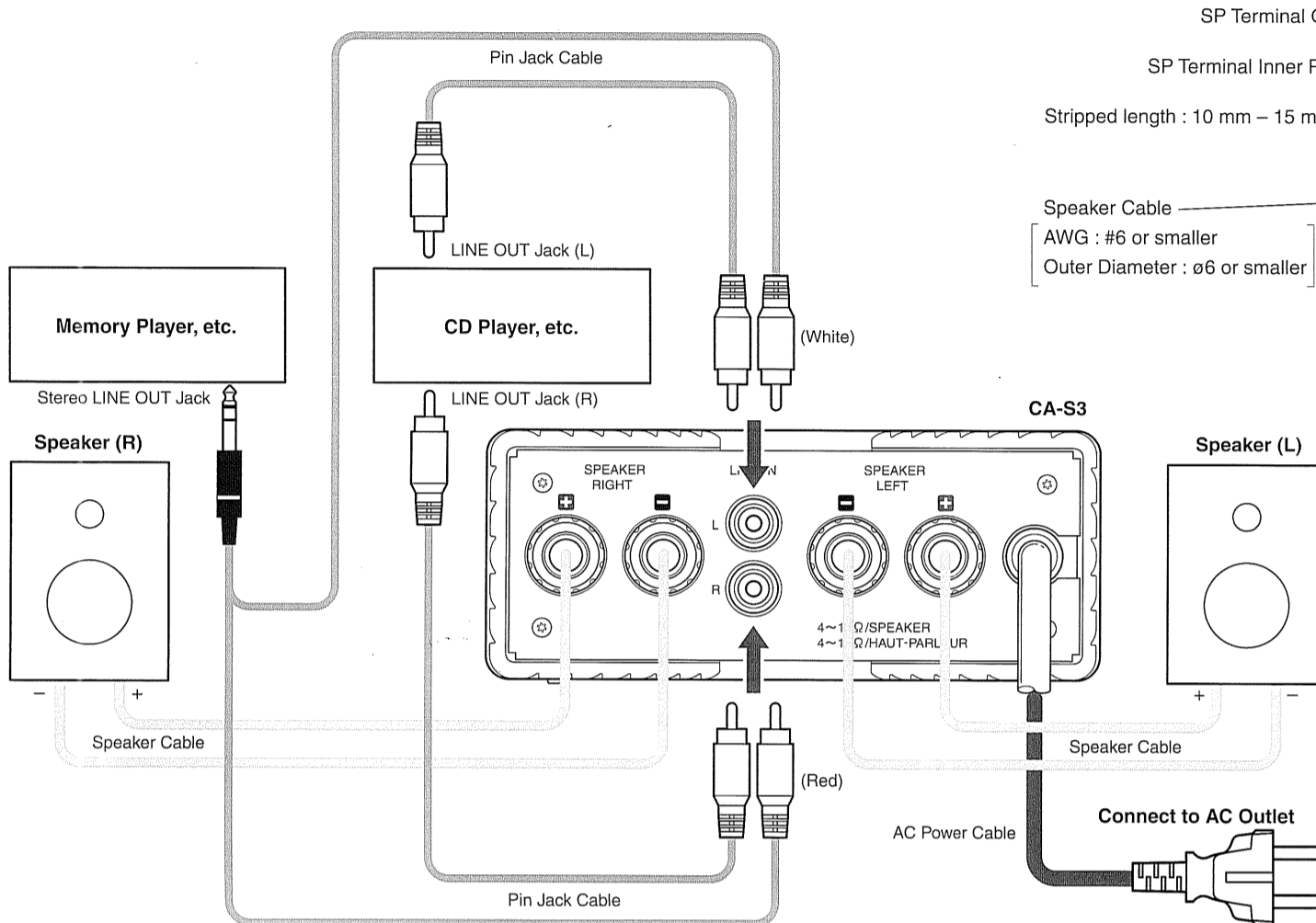

Connecting a Speaker Cable

- ① Remove the SP terminal outer part and then screw in to the inner part by one to three turns.
- ② Strip the cover of the speaker cable by 10 to 15 mm (3/8" to 9/16").
- ③ Press the speaker cable on the SP terminal inner part.
(If the cable core is not a single wire but a stranded wire, press the middle portion of the wire onto the end of the SP terminal inner part.)
- ④ While pushing the speaker cable to the SP terminal inner part, screw in the SP terminal outer part.

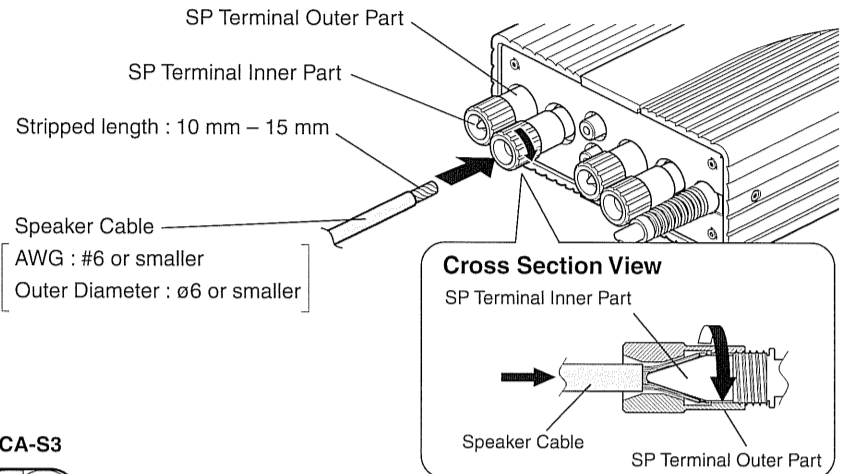

Caution

- If this apparatus is left with the SP terminal inner part exposed, you may accidentally get hurt with the tip of the part.
- Only remove the SP terminal outer part during the connection of speaker cables.

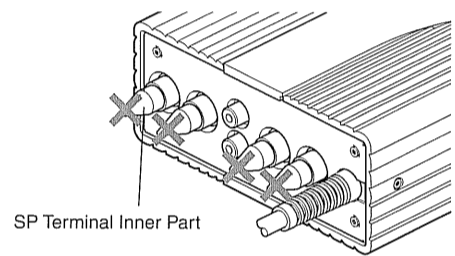

5 Specifications

| | |
|------------------------------|--|
| Rated Output | 30W x 2 (4Ω) / 20W x 2 (8Ω) |
| Frequency Response | 5Hz ~ 50kHz (+0 / -3dB) / (8Ω / 1W) |
| Total Harmonic Distortion | 0.05% (15W / 4Ω / 1kHz, 10W / 8Ω / 1kHz) |
| S/N Ratio | 98dB (400Hz ~ 30kHz BPF) |
| Input Impedance | 50kΩ |
| Input Jack | RCA PIN (Unbalanced) |
| SP Output Terminal | Newly-developed solderless type |
| Conforming Speaker Impedance | 4 ~ 16Ω |
| Power Consumption | 15W |
| Power Supply | AC120V 60Hz (U.S.A. & Canadian model) / AC230V 50Hz (European model) Other areas : mentioned on the sheet attached on the bottom cover. |
| Use environment | 0°C ~ 40°C 32°F ~ 104°F |
| Max. Dimensions | 5-3/16"(W) x 2-1/8"(H) x 7-1/16"(D) / 131(W) x 54(H) x 179(D) mm |
| Weight | 1.4kg (3.1 lbs) |

* Due to product improvement, specifications and/or product design are subject to change without notice.

6 Dimensions

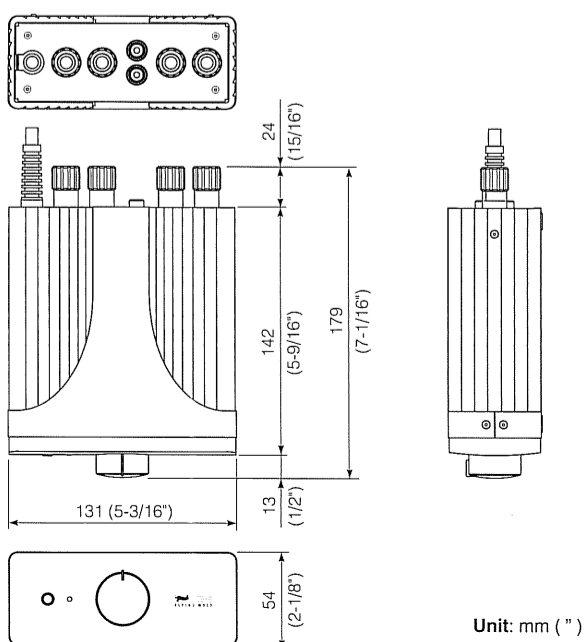

Unit: mm (")

7 Maintenance

Never use liquids such as benzine, thinners, etc., chemically treated cloths, and do not spray any aerosol type insecticides on the amplifier. Clean the case using only a soft, dry cloth. If the amplifier becomes soiled, mix a solution of water and a neutral detergent then dampen a soft cloth in the solution, wring out as much of the solution as possible, and clean the amplifier. Then use a soft, dry cloth to wipe the surface dry.

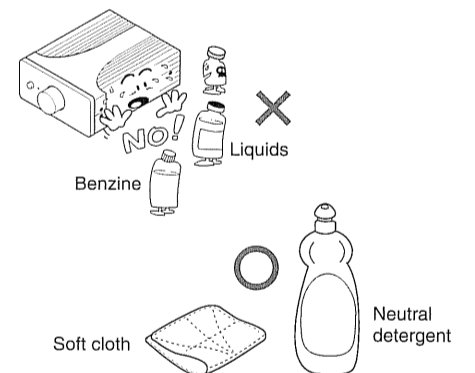

8 Limited Warranty

Warranty period is shown by the distributor in your market. In case defects occur during this period not due to mishandling or modification, please send the product together with proof of purchase to the dealer where you had purchased or to the following address if it is shown.

9 Questionnaire

There is a questionnaire in the "Support" section in our website. This is for helping us serve you better by developing new products. We look forward to your access to the following URL.

<http://www.flyingmole.co.jp>

Protection of Personal Information

We use personal information in the questionnaire only for servicing you and for product development. We take safety measures to prevent leakage of the information as much as we can and we do not reveal it to a third party without your consent.

This document is printed with soy ink (an organic ink made from soy oil) on recycled paper. Environmentally friendly printed matter.

FLYING MOLE CORPORATION
Waji-cho 5199-1, Hamamatsu-shi, 431-1115 Japan
Tel : +81-53-486-6030 Fax : +81-53-486-6033
<http://www.flyingmole.co.jp> info@flyingmole.co.jp